

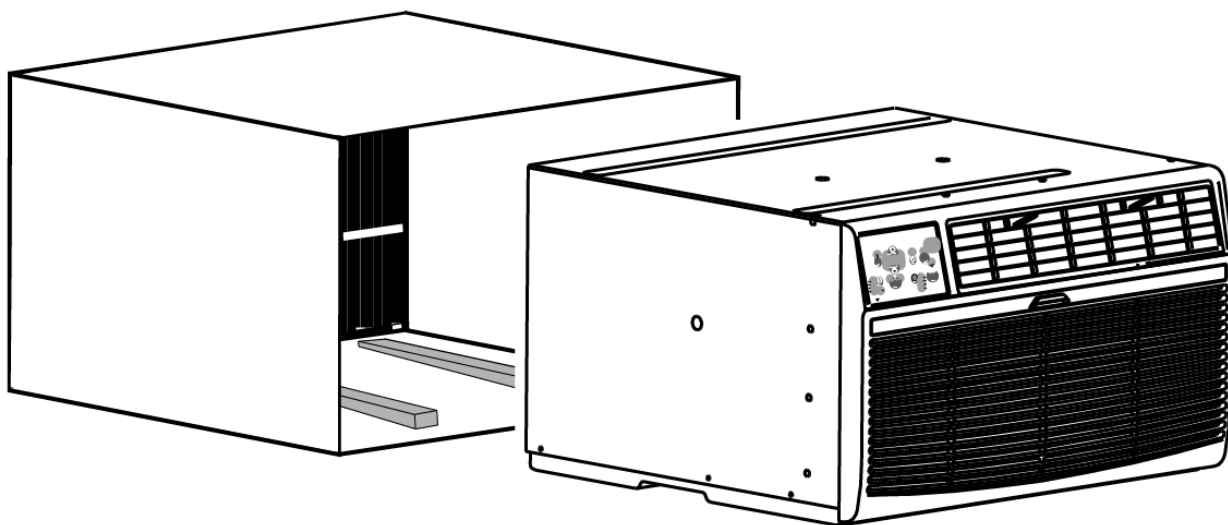

Through The Wall Air Conditioner Installation Instructions



Component Identification

Air Conditioner Unit

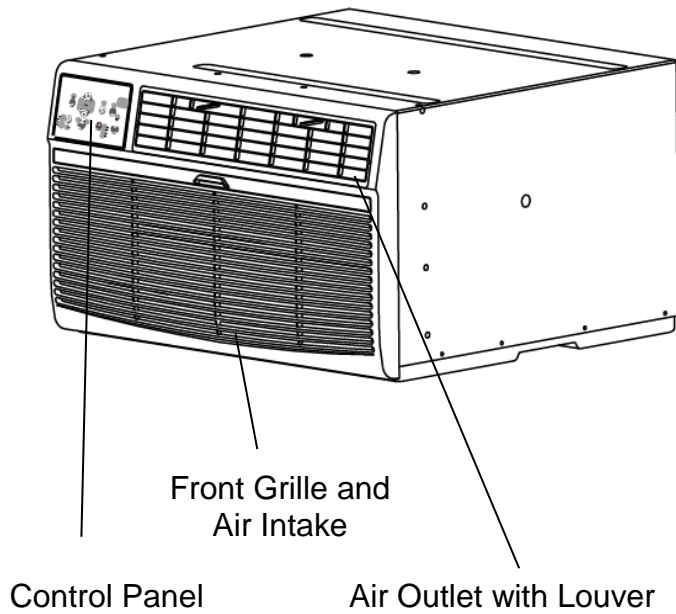

Wall Sleeve (purchased or provided separately)

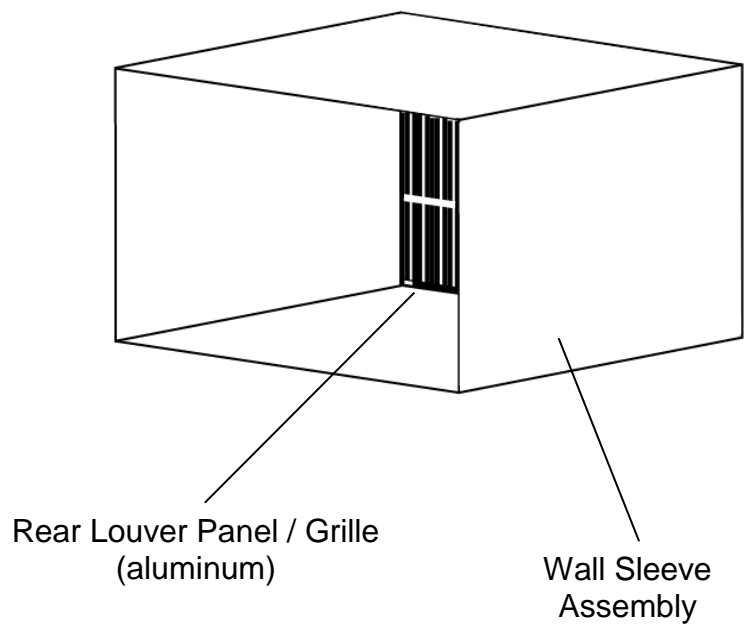

Preparations for Installation



NOTE: You may need to contact an electrician if your room's circuit is not able to power your unit.

NOTE: To avoid risk of injury and/or product/property damage, please take the following precautions:

- Two or more people are needed to properly handle and install.
- Use proper lifting and carrying techniques.
- Before installation, make sure to inspect the window and sill to ensure they are able to handle the weight and size of this unit.
- Wearing protective gloves will help to avoid injury from sharp edges.

Before you begin, make sure you have all the parts and tools necessary for installation.

Tools You May Need:

• Flat Screwdriver or Putty Knife • Phillips Screwdriver • Tape Measure • Level • Drill

Parts Supplied:

Below parts are intended to be used in conjunction with a Koldfront branded Wall Sleeve.

Part Name	Size	Qty Included
Horizontal Insulation Seals	1" x 3/8" x 25"	1
Vertical Insulation Seals	1" x 3/8" x 14"	2
Horizontal Insulation Seals	1" x 3/4" x 14"	2
Foam Support Blocks	1" x 1 1/2" x 14"	2
Tapered Support Blocks	1" x 1" x 17" (tapered to 3/4")	2
Main Insulating Seal (stuffer seal)	1" x 1 1/2" x 84"	1
Trim Frame (sides)		2
Trim Frame (top / bottom)		2
Ground Wire (green)		1
Toothed washers for grounding screw		2
Grounding Screw		1
Rear Louver Panel / Grille (aluminum)		1
Nuts (plastic)		4
Washers (for screws)		4
Screws		4

Additional and/or duplicate parts noted below have been included to allow for installation into non-Koldfront branded Wall Sleeves or to accommodate non-standard installation scenarios. Any unused parts may be discarded at your discretion.

Part Name	Size	Qty Included
Centering / Support Blocks	4 1/2" x 3 1/2" x 1 1/2"	4
Plastic Divider	1/8" x 4 1/2" x 14 1/2" x	2
Horizontal Insulation Seals	1" x 3/8" x 25"	2
Horizontal Insulation Seals	1" x 1 1/2" x 25"	3

Installation Instructions



NOTE: When choosing your window make sure power supply cord is within 4 feet of a grounded 3-prong outlet.

Basic Installation Steps

- Prepare Wall Sleeve
- Install rear Louver Panel / Grille into Wall Sleeve
- Attach Seals inside wall sleeve
- Prepare grounding wire
- Insert Air Conditioner Unit into Wall Sleeve and attach Ground Wire
- Insert Main Seal
- Attach Front Frame pieces

Keys to proper installation

- Wall sleeve is secure and properly sealed to the wall.
- Unit has a slight rearward slope within wall sleeve for proper drainage (use tapered foam blocks).
- Air conditioner unit is centered in wall sleeve and sealed (with foam pads) to prevent air leakage.

Before Getting Started

Your Koldfront though the wall air conditioner is designed to be installed in conjunction with a wall sleeve. If you are installing your new Koldfront air conditioner into an existing wall sleeve, please check to confirm that the wall sleeve is in sound structural condition and that is sized appropriately to accommodate your Koldfront air conditioner. For reference, your new Koldfront Air Conditioner is 24 $\frac{1}{4}$ " x 20 $\frac{3}{8}$ " x 14 $\frac{1}{2}$ "

IMPORTANT: When installation is complete, the unit **MUST** have a rearward slope as shown in the image below to ensure proper drainage. This is accomplished by using the Tapered Support Blocks as noted in the "Attach Seals" section of this document.

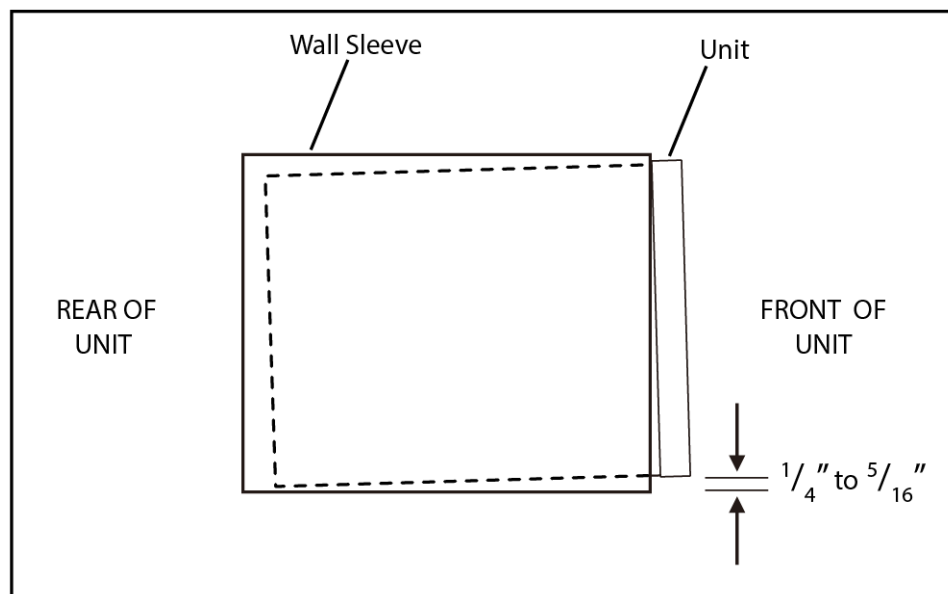

Preparing the Wall Sleeve

Your Koldfront Through The Wall Air Conditioner unit is intended to be installed into a compatible wall sleeve enclosure. A wall sleeve provides the proper support and enclosure for your air conditioner and allows for the wall opening to be properly sealed prior to final installation.

NOTE: The Koldfront Through the Wall Air Conditioner Sleeve (Model: WTCSLV) is designed specifically for Koldfront's line of through the wall air conditioners and can be purchased at www.edgestar.com

To properly install your new Koldfront Through The Wall Air Conditioner into a wall sleeve, it is required that you use the Rear Louver Panel / Grille that was shipped with your new air conditioning unit. This will ensure proper air flow from the back of the unit. If your installation utilizes a previously installed wall sleeve, please replace the Rear Louver Panel / Grille with the one provided with your new air conditioner.

Install Rear Louver Panel / Grille into NEW Wall Sleeve

Assemble and install your new wall sleeve according to the manufacturer's instructions. Basic instructions are as follows:

1. Prepare and install the new wall sleeve according to the manufacturer's instructions. Ensure that the wall sleeve is properly fastened to the wall a minimum of 4" from any heating source and that high-grade sealant / caulking has been used to prevent air and water infiltration.
2. Place the Rear Louver Panel / Grille included with your new air conditioner towards the rear of the sleeve.
3. Mark the mounting hole positions.
4. Drill through the sleeves flanges with a 1/8" drill bit.
5. Attach the Rear Louver Panel / Grille included with your new air conditioner unit with self-threading screws and washers. (See following page.)

Preparation of Previously Installed Wall Sleeve

To install the rear louver panel / grille provided with your new air conditioner unit into an existing wall sleeve installation:

1. Remove the existing Rear Louver Panel / Grille.
2. Clean the interior and exterior of the wall sleeve and verify that all seals are in proper condition. Replace seals if needed with the seals that have been provided with this unit.
3. Place the Rear Louver Panel / Grille included with your new air conditioner towards the rear of the sleeve.
4. Mark the mounting hole positions.
5. Drill through the sleeves flanges with a 1/8" drill bit.
6. Attach the Rear Louver Panel / Grille included with your new air conditioner unit with self-threading screws and washers. (See following page.)
7. Most existing decorative exterior grilles may be left in place as long as the proper interior air direction grille is installed.

Rear Louver Panel / Grille Installation into Wall Sleeve Diagram

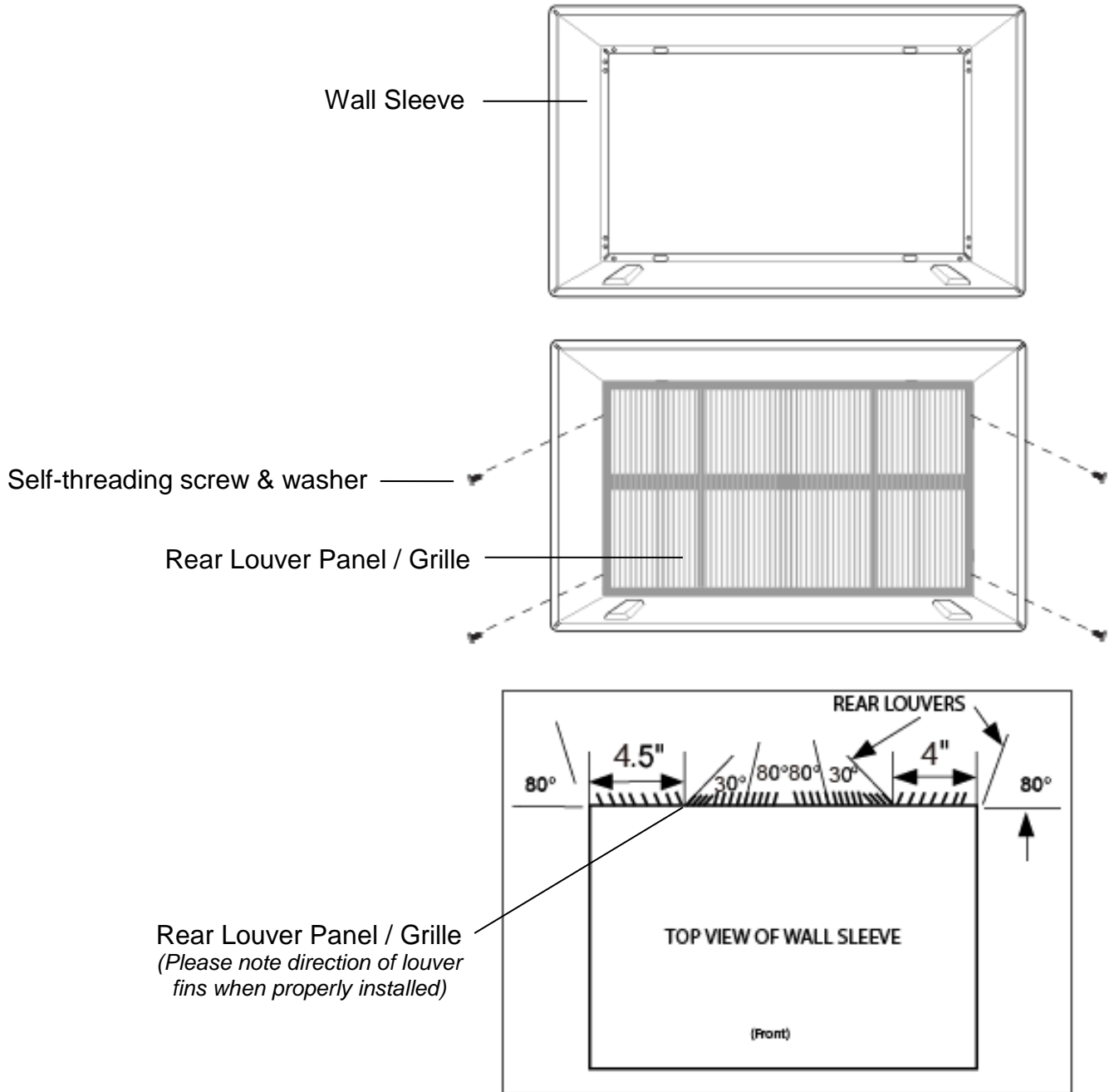

IMPORTANT: Please ensure that the Rear Louver Panel / Grille is installed correctly to ensure proper airflow and performance. Please note the direction and alignment of the louvered fins.

Also, please note that when aligned as instructed above, the holes in the louver panel / grille will properly line up to the holes in the Koldfront wall sleeve.

If you are unable to secure the Rear Panel Louver / Grille to the wall sleeve, it may be attached directly to the rear of the air conditioning unit. Please see the "Alternate and Supplemental Installation Instructions" found in this document.

Attach Seals and Support Blocks to Wall Sleeve

With the wall sleeve properly assembled, it is now time to prepare the wall sleeve enclosure for the air conditioner unit. The process involves positioning seals and foam support blocks inside of the wall sleeve enclosure in order to enable a proper fit for the air conditioning unit.

IMPORTANT: The below instructions are to be used in conjunction with the Koldfront Wall Sleeve model WTCSLV. Instructions for other compatible wall sleeves can be found in the "Alternate and Supplemental Installation Instructions" found in this document.

1. Attach 1 (one) - 1" x $\frac{3}{8}$ " x 25"
Horizontal Insulation Seal as indicated.



2. Attach 2 (two) - 1" x $\frac{3}{8}$ " x 14"
Vertical Insulation Seals as indicated.

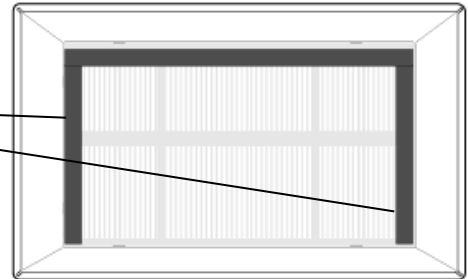

3. Attach 2 (two) - 1" x $\frac{3}{4}$ " x 14"
Horizontal Insulation Seals as indicated.
(Attach 4½" from left side and 4" from right side)

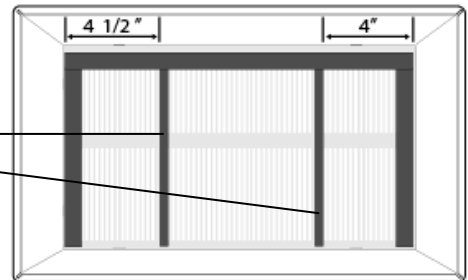

4. Attach 2 (two) - 1" x 1½" x 14"
Foam Support Blocks is indicated.

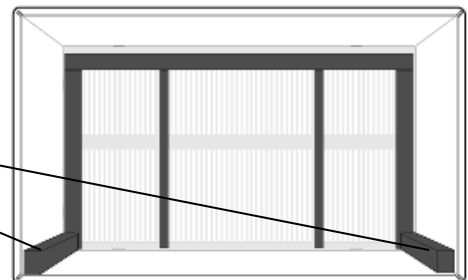

5. Attach 2 (two) - 1" x 1" x 17"
Tapered Support Blocks as indicated.

NOTE: The tapered support blocks are sloped from 1" at the front down to ¾" on the back. Please attach accordingly to allow for the unit to have a slight rearward slant when installed. This will help ensure proper drainage.

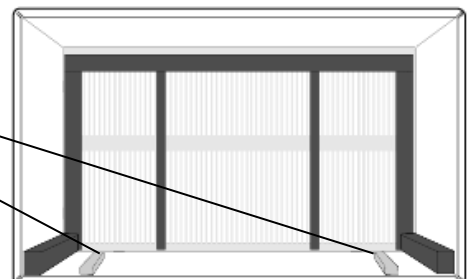

Prepare Ground Wire

To properly ground the air conditioner unit, the ground wire must be secured to the frame of the wall sleeve. When the air conditioner unit is placed inside of the wall sleeve, this ground wire will be attached to the air conditioner frame to allow for proper grounding of the air conditioner unit.

NOTE: This step may require the use of a drill with a 1/8" drill bit. If your wall sleeve has been previously installed, there may be no requirement to drill a new hole for the grounding screw. If using the Koldfront wall sleeve (model WTCSLV), the hole should be pre-drilled for you.

Also, please note that additional fastener types may have been included and may be used to suit your particular installation setup.

1. Locate the following parts:

- Grounding Screw (1)
- Toothed Grounding Screw Washer
- Ground Wire

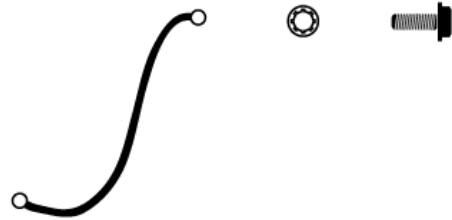

2. As needed, use your drill and 1/8" bit to drill a hole for the grounding screw. The hole needs to be approximately 1" from the bottom and 3" from the front edge of the wall sleeve on the left side.

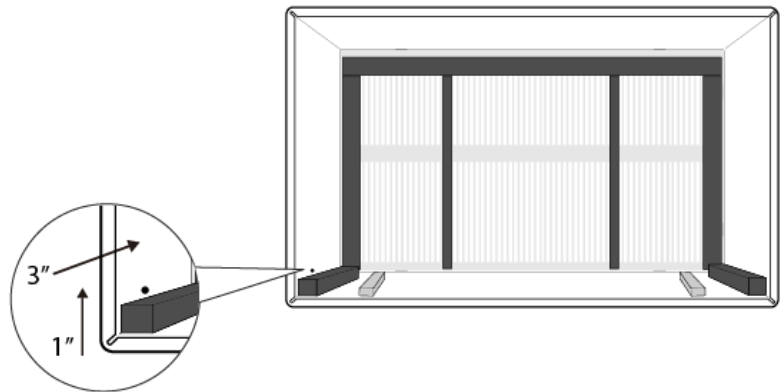

3. Attach one end of ground wire using 1 (one) Toothed Washer and 1 (one) Grounding Screw

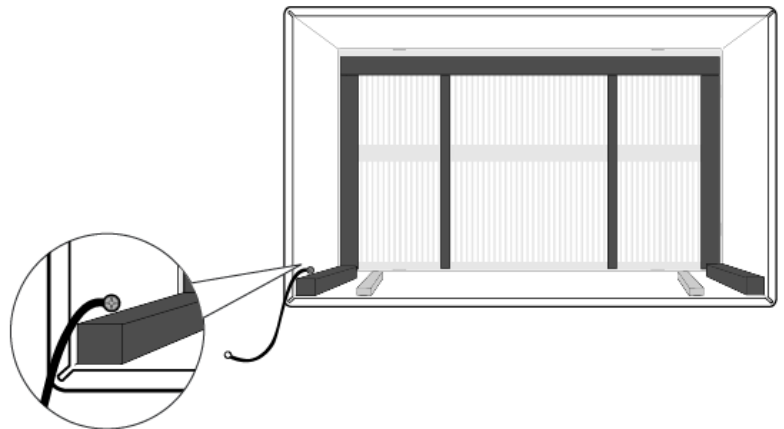

Install Air Conditioner Unit into Wall Sleeve

With the wall sleeve fully prepared, you are now ready to insert the air conditioner unit into the wall sleeve. Two or more people may be required for this step.

1. Remove the 2nd screw on the left lower side of the air conditioner cabinet. Set aside and/or discard the plastic washer.

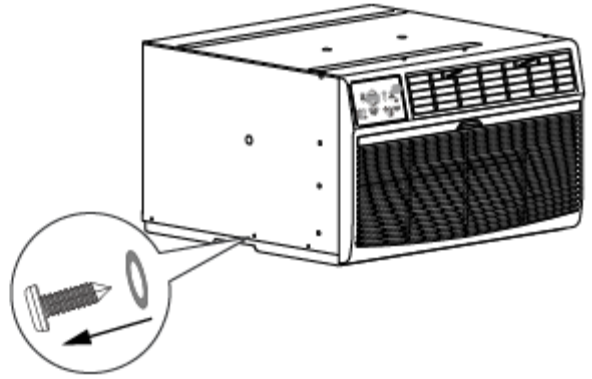

2. The ground wire will be attached to the air conditioner cabinet using the screw you just removed along with a Toothed Washer.

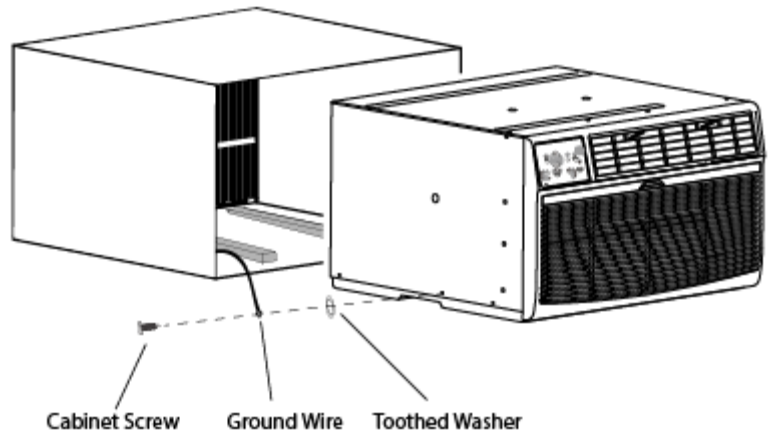

3. Gently slide the air conditioner cabinet into the Wall Sleeve. With the 2nd screw hole still exposed, attach the ground wire to the cabinet using the cabinet screw making sure that the Toothed Washer is pressed against the cabinet.

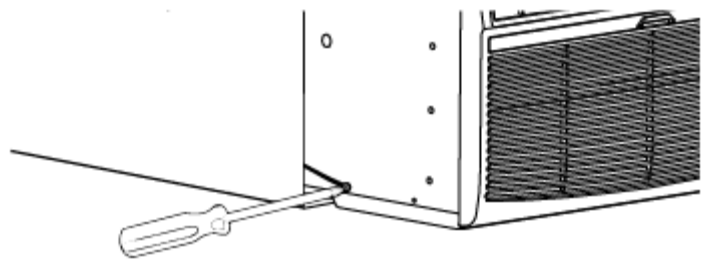

4. Slide air conditioner completely to the rear of the wall sleeve unit ensuring that all seals and foam support blocks create snug fit for the unit. Please be sure that the ground wire does not become entangled when the unit is pushed back into the wall sleeve.

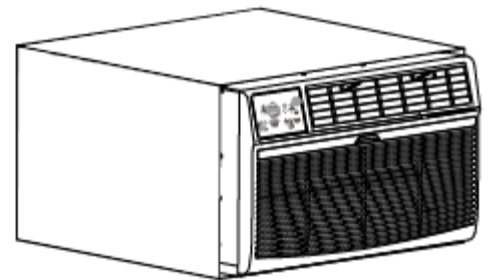

Completing Installation

With the air conditioner installed into the Wall Sleeve and the ground wire properly attached, it is time to complete installation by inserting the Main Insulating Seal (stuffer seal) and attaching the Trim Frame.

1. Locate the Main Insulating Seal (stuffer seal) included with the installation kit. This is the longest seal and measures 1" x 1 1/2" x 84". Using a putty knife or flathead screwdriver, insert the seal into the gap between the air conditioner cabinet and the Wall Sleeve frame. Trim seal as needed.

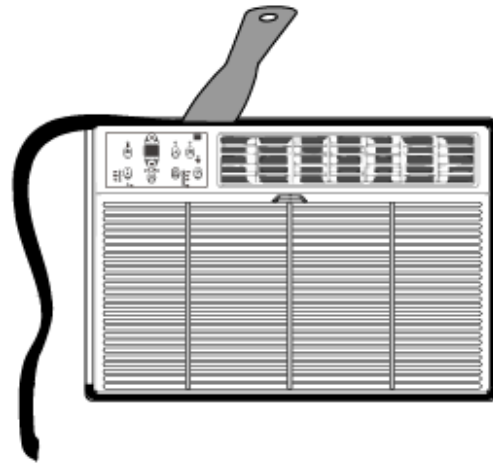

2. Locate the 4 (four) trim kit components that were packaged with your installation kit. Snap the pieces together as shown in the image to the right.

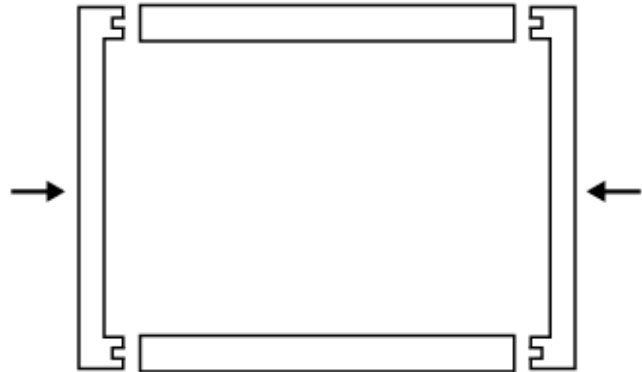

3. Pull the power cord through the Trim Kit frame and then slide the Trim Kit Frame over the unit until flush with the wall.

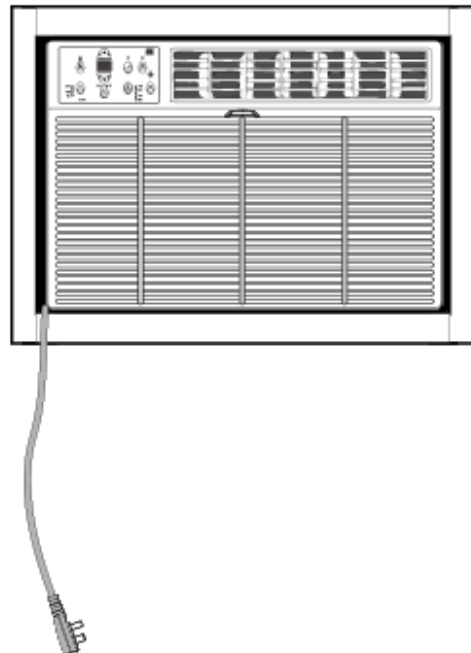

Alternate and Supplemental Installation Instructions

The below instructions may be referenced for scenarios in which the standard installation procedures cannot be followed.

Install Rear Louver Panel / Grille Directly on Back of Air Conditioner

If your installation scenario does not allow you to attach the Rear Louver Panel / Grille to the Wall Sleeve you may carefully secure the Panel directly to the rear of the Air Conditioner unit.

1. Attach 1" x 3/8" x 14" seal pieces.
2. Position Grille over rear of air conditioner ensuring that:
 - The double set of screw holes are on the bottom.
 - The Grille fins are pointed away from unit.
3. Align the top of the Grille with the top of the air conditioner unit.
 - Holes should be pre-drilled, but if required, carefully pre-drill 4 (four) 1/8" holes through the Grille and into the side flange of the air conditioner cabinet frame approximately 1 1/2" – 2" from the top and bottom.
4. Attach Grille to unit with 4 (four) self-tapping screws.
5. Install unit into sleeve.

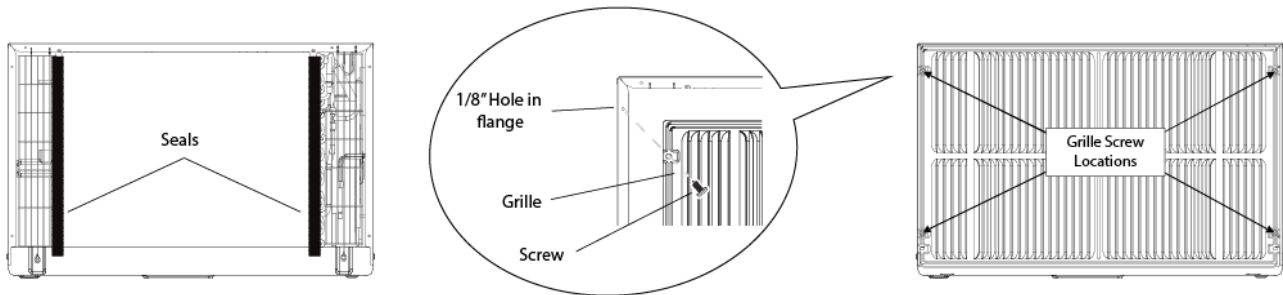

Non-Koldfront Wall Sleeve Types

The below diagrams may be used as a reference when installing your Koldfront Through The Wall Air Conditioner into a non-Koldfront branded Wall Sleeve. Regardless of brand, please ensure your wall sleeve is securely installed into the wall opening and is properly sealed. Additionally, as noted previously, please ensure that your air conditioner is installed with a slight rearward tilt to allow for proper drainage.

GE / Hotpoint (16 7/8" Depth)
Sears or Carrier (18 5/8" Depth)
Whirlpool (17 1/8" Depth)

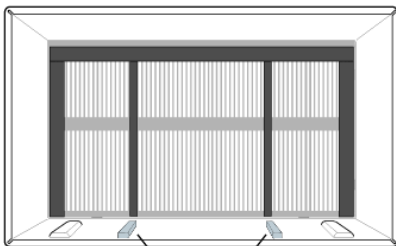

Tapered Support Blocks

Emerson Wall Sleeve (15" Depth)
Fedders (19 3/4" Depth)
Fedders or Freiderich (16 3/4" Depth)

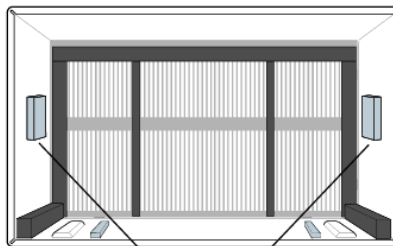

Centering / Support Blocks

Whirlpool Wall Sleeve (23" Depth)
Westinghouse or Frigidaire Wall Sleeve (22" Depth)

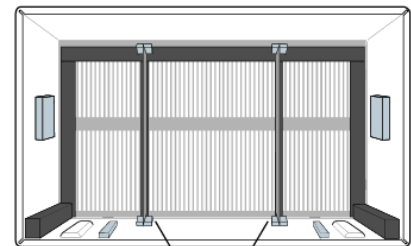

Plastic Dividers with Support Blocks