

Koldfront

Window Air Conditioner

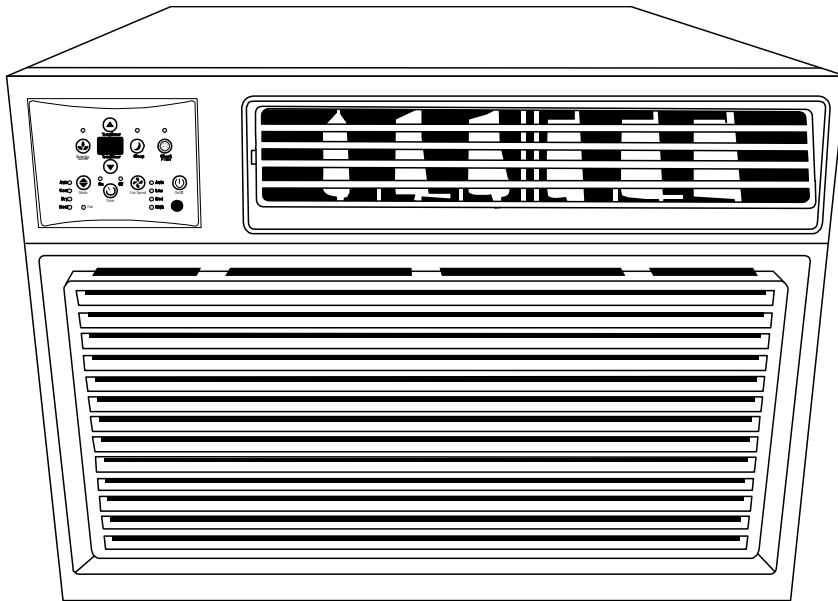

WAC8000W

Owner's Manual

For more information on other great EdgeStar products on the web, go to <http://www.edgestar.com>

Important Safety Information

Improper handling can cause serious damage to the Koldfront Window Air Conditioner and/or to the user. Please review the rating label located on the rear panel of the unit for electrical and other technical data related to this unit. The unit must be used in a properly grounded wall outlet. Please read and follow the safety information listed below to reduce the risk of fire, electric shock or injury.



Warning: The water produced by the window AC is not potable or suitable for drinking.

Do not drink the water drained from the unit as it contains contaminants and could make you sick.



Electrical Safety

- Make sure your hands are dry and not wet before operating the unit.
- Do not wet the front housing or control panel.
- Do not directly spray water on this Air Conditioner.
- Do not pull the unit by the cord.
- Always turn the unit off and unplug it from the socket when cleaning.
- Unplug the unit if it is not going to be used for a long period of time.
- Do not operate the unit with a damaged or loose plug and / or socket.
- Use only the correct power supply with appropriate amperage.
- If the power cord is damaged, it must be replaced by the manufacturer, a service agent, or qualified technician.
- Do not turn the unit off or on by inserting or pulling the power plug.
- Do not modify the power cord length or share the outlet with another appliance.
- Do not use this unit with an extension cord and/or adapter plug.
- Do not use this unit near flammable gases/combustibles or close proximity to heating appliances.
- During operation do not remove any part of the outside casing.



General Safety

- Do not let people or pets sit or set an object directly in front of air flow.
- If a strange sound, smell, or smoke comes from the unit, turn it off and review the troubleshooting page of this manual.
- Stop operation and unplug unit in the event of a severe storm.
- To ensure proper air flow and intake, make sure the air vents are not obstructed.
- See instructions for cleaning air filters and how often cleaning should occur.
- Do not use strong detergents when cleaning.
- Children should be supervised when operating this unit.
- Do not allow children to play with the controls or drop any objects into the air outlets or vents.
- Do not place objects or let any person sit on top of the unit.
- Route the power cord carefully to avoid a tripping hazard.
- This unit is intended for domestic home use only. Do not use the window air conditioner for commercial or industrial use. Any other use may invalidate the warranty.
- Use caution when unpacking and installing the unit as there may be some sharp edges.

Operation of Safety Plug

Your window air conditioner is supplied with a Leakage-Current Detection and Interruption (LCDI) safety plug. This device provides protection to reduce the risk of fire due to arcing faults in the power supply cord. Before using your window air conditioner, follow the instructions below to ensure that the LCDI plug is working properly:

1. Plug the power cord to a grounded outlet.
2. Press the TEST button on the LCDI plug. This should trip the plug and cut the power to the air conditioner. If the plug does not trip and you are able to turn on the unit, please contact EdgeStar support.

DO NOT USE YOUR WINDOW AIR CONDITIONER IF THE TEST FAILS.

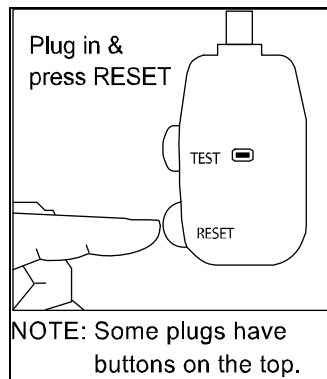

3. Press the RESET button to start using your air conditioner.

NOTES:

- Always make sure the “Reset” button is pushed in for proper operation.
- The power supply cord with LCDI plug must be replaced if it fails to reset.
- Do not use the TEST and RESET buttons as an ON/OFF switch.

Electrical products should not be disposed of with household waste. Please contact your local recycling center for more information on how to recycle electronic waste.



Table of Contents

IMPORTANT SAFETY INFORMATION	I
OPERATION OF SAFETY PLUG.....	II
TABLE OF CONTENTS	1
PARTS IDENTIFICATION	3
SIDE VIEW	3
FRONT VIEW	3
PREPARATIONS FOR INSTALLATION	4
PARTS SUPPLIED:	ERROR! BOOKMARK NOT DEFINED.
WINDOW INSTALLATION INSTRUCTIONS	5
PREPARING THE UNIT FOR WINDOW INSTALLATION	5
<i>Remove the Air Conditioner unit from Cabinet.</i>	5
<i>Attaching the Top Channel and Side curtains</i>	5
<i>Attaching Foam Adhesive</i>	6
INSTALLING CABINET INTO WINDOW	7
ATTACH SIDE CURTAINS TO WINDOW FRAME	8
COMPLETING INSTALLATION	9
CONTROL PANEL OPERATIONS	10
TO TURN UNIT ON:	10
TO CHANGE TEMPERATURE:.....	10
TO ADJUST FAN SPEEDS:.....	10
TO SELECT OPERATING MODE:	11
<i>To operate on Auto Feature:</i>	11
<i>To operate on Fan Only:</i>	11
<i>To operate on Dry mode:</i>	11
TO USE ENERGY SAVER FEATURE:.....	11
TO USE THE SLEEP FEATURE:	11
TO USE TIMER (AUTO START/STOP) FEATURE:	12
TO CHECK FILTER FEATURE:	12
DIGITAL DISPLAY:.....	12
<i>Error Codes</i>	12
AIR DIRECTIONAL LOUVERS:.....	13
ADDITIONAL TIPS:	13
REMOTE OPERATIONS	14
MAINTENANCE	15
AIR FILTER CLEANING	15
CABINET CLEANING.....	15
NORMAL SOUNDS	16
ENERGY SAVING GUIDE	16
TROUBLESHOOTING	17
SPECIFICATIONS	19
EDGE STAR LIMITED WARRANTY	20

INTRODUCTION

Thank you for purchasing this Koldfront window air conditioner. We are glad you chose us. We believe that your purchase of this product opens a relationship between you and Koldfront. We will provide the customer support needed to nurture that relationship.

This manual contains important information regarding the proper installation, use and maintenance of your window air conditioner. Following this manual will ensure that your product will work at its peak performance and efficiency.

Please save the original product packaging in case you need to safely transport your window air conditioner.

For Your Records:

Please write down the model number and serial number below for future reference. Both numbers are located on the ratings label on the back of your unit and are needed to obtain warranty service. You may also want to staple your receipt to this manual as it is the proof of your purchase, and is also needed for service under your warranty.

Model Number: _____

Serial Number: _____

Date of Purchase: _____

To better serve you, please do the following before contacting customer service:

- If you received a damaged product, immediately contact the dealer that sold you the product.
- Read and follow this instruction manual carefully to help you install, use and maintain your window air conditioner.
- Read the troubleshooting section of this manual as it will help you diagnose and solve common issues.
- Visit us on the web at <http://www.edgestar.com> for product guides, additional troubleshooting resources and up-to-date information. If you need service, our friendly customer service representatives are available via email at service@edgestar.com or by telephone at **1 (866) 319-5473**.

Parts Identification

Side View

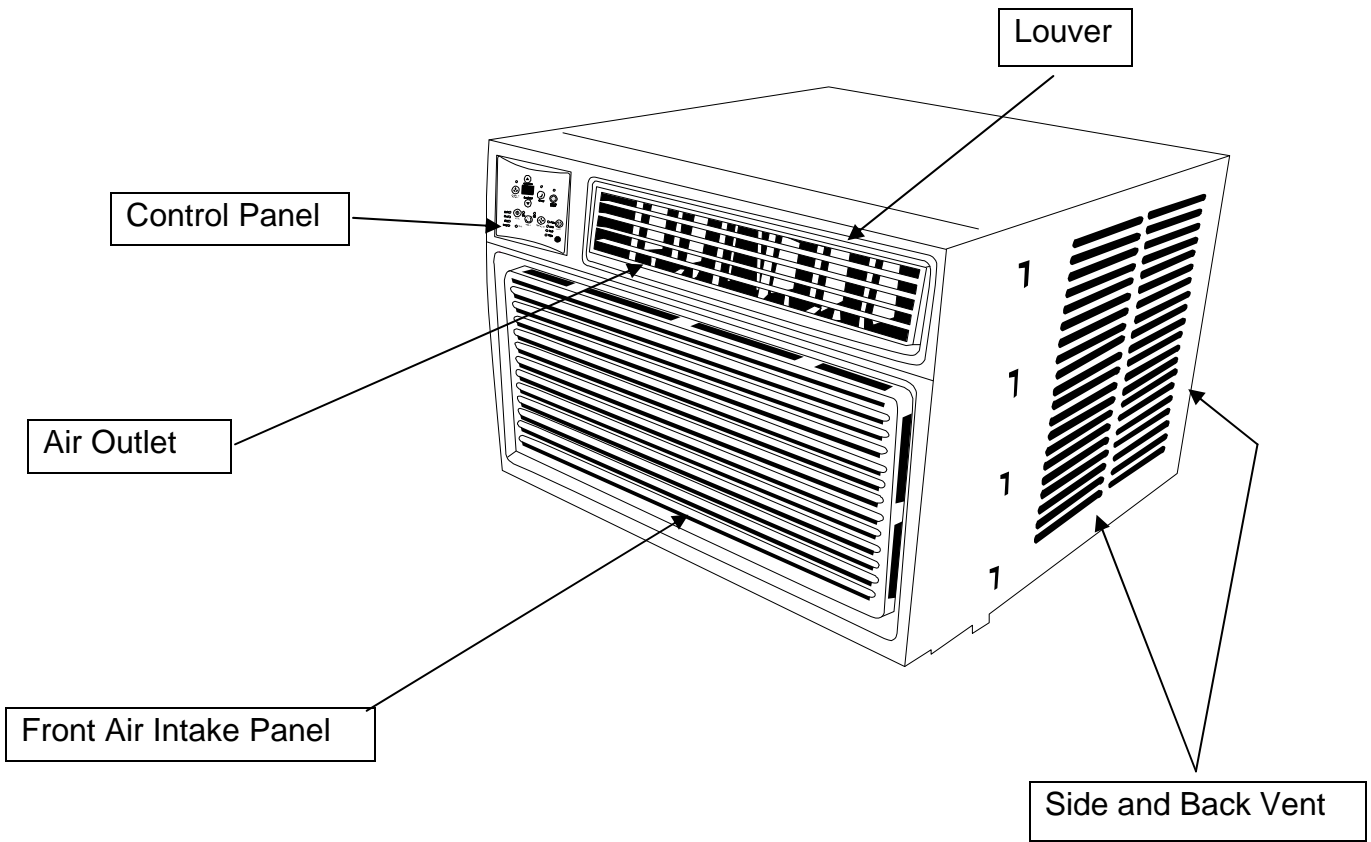

Front View

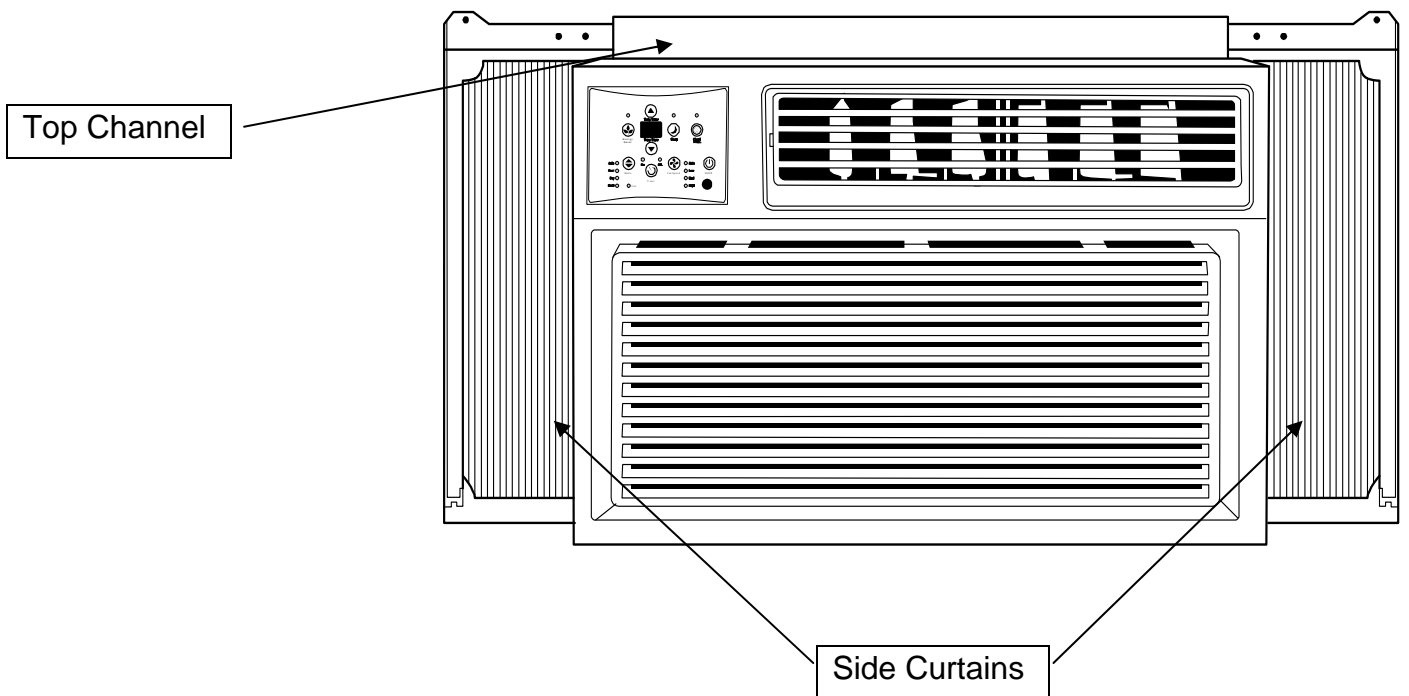

Preparations for Installation

Tools Needed:







Flat Screwdriver
Phillips Screwdriver
Tape Measure
Level
Drill

NOTE: To avoid risk of injury and/or product/property damage, please take the following precautions:

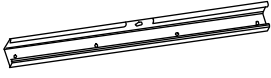
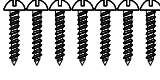
- Two or more people are needed to properly handle and install.
- Use proper lifting and carrying techniques.
- Before installation, make sure to inspect the window and sill are able to handle the weight and size of this unit.
- Wearing protective gloves will help to avoid injury from sharp edges.

Before you begin, make sure you have all the parts necessary for installation.

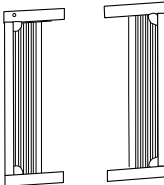
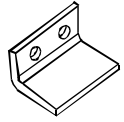
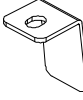
PARTS SUPPLIED:

 <p>(3) #10 x 1/2" Phillip Screws</p>	 <p>(1) Top Channel</p>
 <p>(7) #10 x 3/4" Flat Screws</p>	 <p>(1) Window Sash Seal</p>
 <p>(5) #10 x 1/4" Phillip Screws</p>	 <p>(1) Foam Seal</p>
 <p>(1) Set of Side Curtains</p>	 <p>(1) Window Lock Bracket</p>
 <p>(2) Safety Lock (vinyl windows)</p>	 <p>(5) Weather Seals</p>

NOTE: You may need to contact your electrician if your room's circuit is not able to power your unit.

If you have multiple windows, choose one that is near an electrical outlet that will be able to provide sufficient power to your unit. See the power requirements listed on the product label printed on the side, or on the back of your window air conditioner.

The following measurements are required to properly install the air conditioner.

- Window Width: 26 7/8" to 36"
- Window Minimum Height: 16 1/2"

Window Installation Instructions

Preparing the unit for window Installation

NOTE: When choosing your window make sure power supply cord is within 4ft of a grounded 3-prong outlet.

Remove the Air Conditioner unit from Cabinet.

1. Remove the air conditioner from the carton and place on cardboard.
2. Remove 1 Shipping Screw from each side. Remove front panel by removing 1 Phillips screw from each side of the front panel. Set screws aside and save.
3. Pull on the handles to slide the air conditioner out of the cabinet. Place the air conditioner on cardboard.

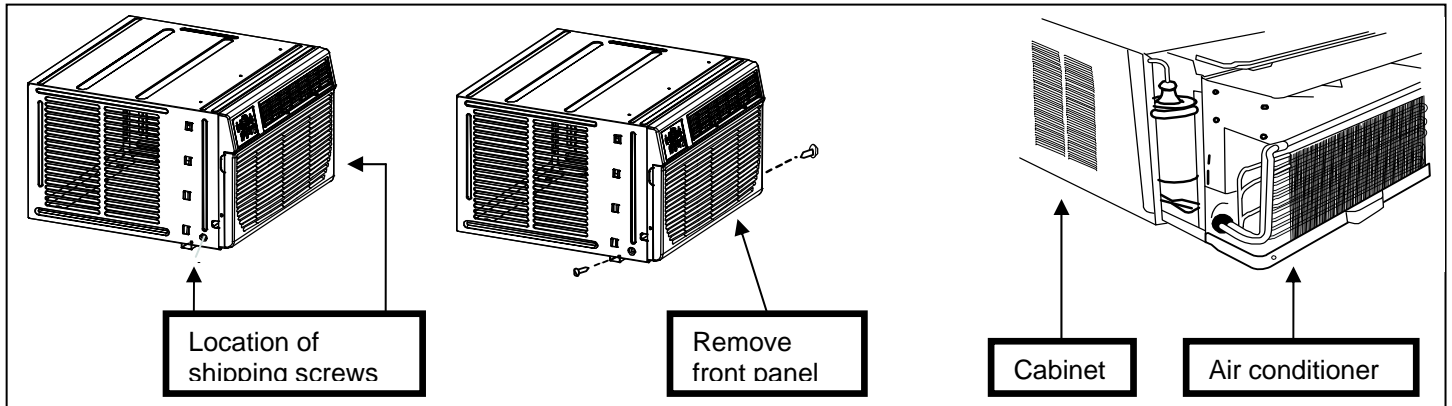

Attaching the Top Channel and Side curtains

Make sure to attach the top channel and side curtains prior to installing the cabinet into the window.

1. Locate provided bag of screws.
2. Place the top channel on top of the air conditioner cabinet, lining up the three holes in the top channel with the three holes on top of the cabinet.
3. Using the indicated screws in figure below attach the top channel to the air conditioner cabinet.

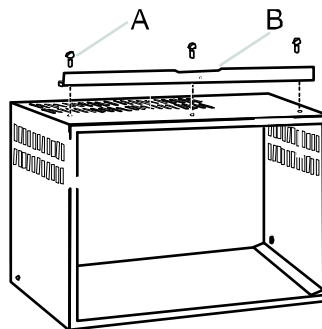

A. # 10 x 1/4" Phillips Screw
B. Top Channel

4. To attach the side curtains to the air conditioner, insert the right-hand curtain connector tab into the curtain housing channels on the air conditioner.

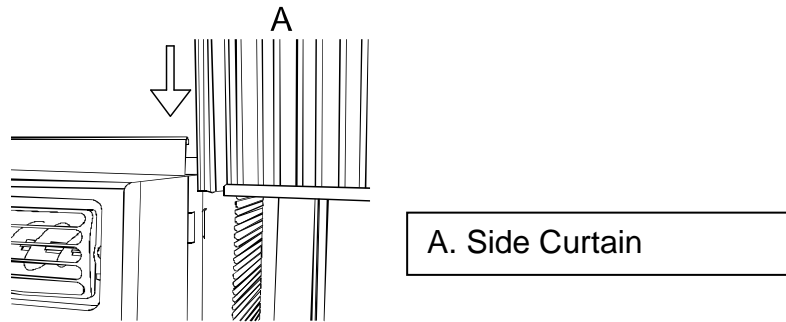

5. Insert the top of the right-hand curtain housing to the top curtain channel as shown below:

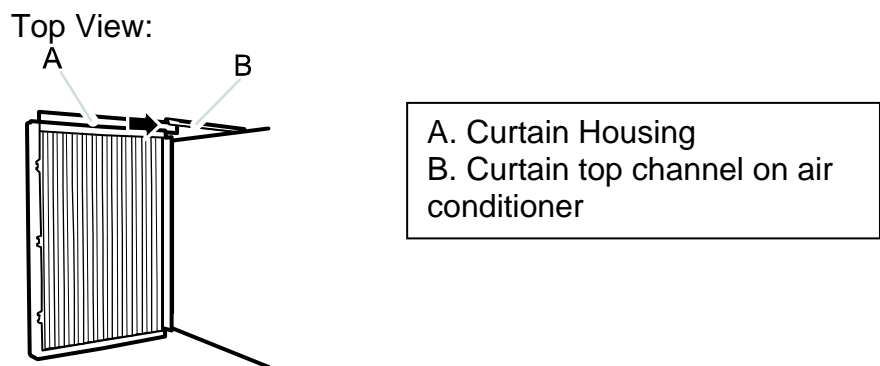

6. Then insert the bottom of the side curtain housing to the bottom channel on the air conditioner as shown below:

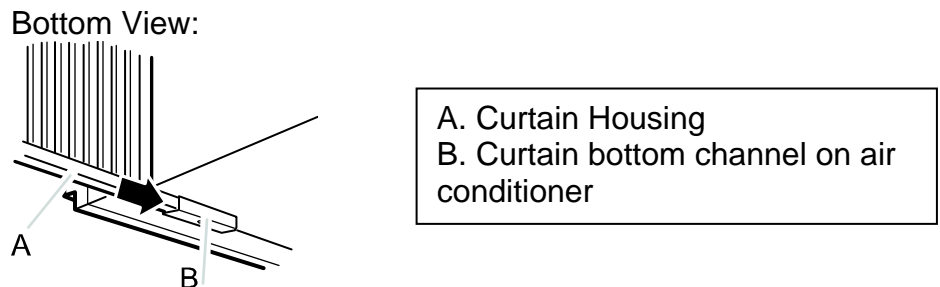

Attaching Foam Adhesive

1. Attach the foam adhesive seal along the bottom of the curtain channel to maximize performance and efficiency.

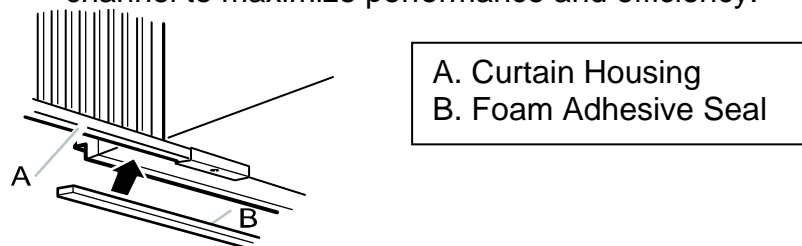

Installing Cabinet into Window

Follow the steps listed below to install the cabinet into the window

1. Center empty cabinet into window:
 - Check that lower rail of air conditioner cabinet is behind and against back side of window sill.
 - Maintain a firm hold on the cabinet and lower window sash to hold the cabinet in place.
 - Measure the distance of the right side and left and adjust until equal distance.
2. There are different methods to secure the cabinet into window depending on the type of window.
 - For Wooden Frames:
 - Use a 3/16" drill bit to drill three starter holes 3/8" deep through the three holes in the cabinet and into the window sill.
 - Drill one starter hole 3/8" deep through the hole in the middle of the top rail and into the window frame.

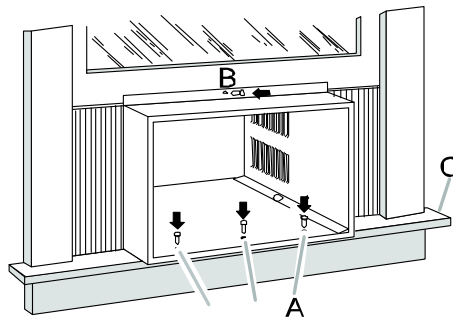

- A. #10 x 1/2" Phillips Screws
- B. #10 x 3/4" Flat Screws
- C. Window Sill

- For Vinyl Windows:
 - Use a 1/8" drill bit to drill one hole through the hole in the middle of the top rail into the window frame. Attach cabinet to window with one #10 x 3/4" Phillips screw (B in figure above).
 - Place two safety locks into the holes that are located at the bottom of the cabinet and drive two locking screws through the safety locks into the cabinet as shown below.

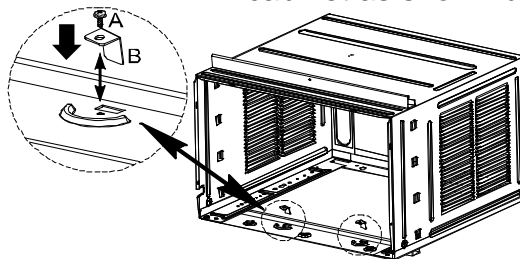

- A. #10 x 3/4" Phillips Screw
- B. Safety Locks (Only for Vinyl Windows)

Attach Side Curtains to Window Frame

1. Extend the side curtains out against the window frame.
2. Drill holes and drive locking screws:
 - Wooden Windows- Use a 3/32" drill bit to drill four starter holes through the holes in the side curtains into window. Screw in four #10 x 3/4" screws through the holes in the side curtains into the window sill.

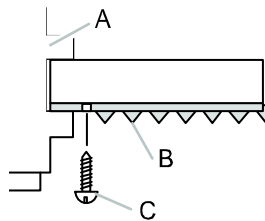

A. Window Channel
B. Left-hand curtain
C. #10 x 3/4" Flat Screw

Figure 1

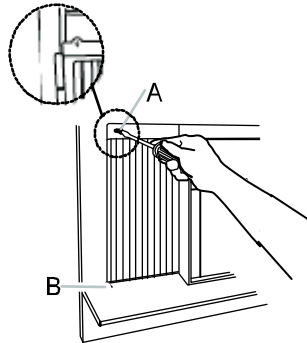

A. #10 x 3/4" Flat Screw
B. Slotted hole in the bottom of the curtain

Figure 2

- Vinyl Windows- Use a 1/8" drill bit to drill two holes through the holes in the side curtains into the window frame. Screw in the #10 x 3/4" Flat Screw through the holes in the side curtains into the window sash. Refer to figure 1 above.
4. Trim the weather seal with a proper length peel off protective backing and plug any gaps if needed as shown in Figure 2.

Completing Installation

1. Insert the window sash seal (C) behind the top of the lower window sash and against the glass of the upper window (B).
2. Place the window-lock bracket (A) on top of lower window and against upper window sash on right side of the window.
3. Use a $3/32$ " drill bit to drill starter holes through the holes in the bracket (A) into the window sash.
4. Attach the window lock-bracket (A) to the window sash with two #10 x $3/4$ " flat screws (D) to secure the window in place.

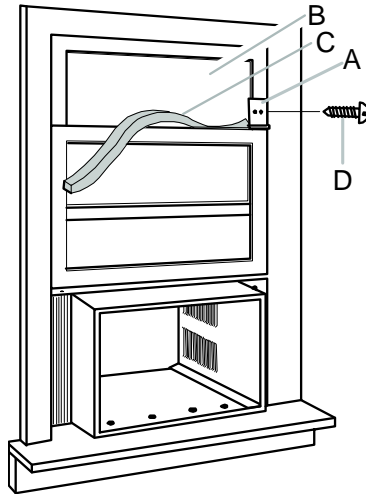

- | |
|------------------------------|
| A. Window Lock Bracket |
| B. Upper Window Glass |
| C. Window Sash Seal |
| D. #10 x $3/4$ " flat screws |

5. Insert Air Conditioner into cabinet.
6. Insert front tabs of front panel into top of cabinet and window front into place.
7. Attach bottom front of panel with the front panel screws.
8. Plug into a grounded 3-prong outlet.
9. Press "Reset" on power cord supply.

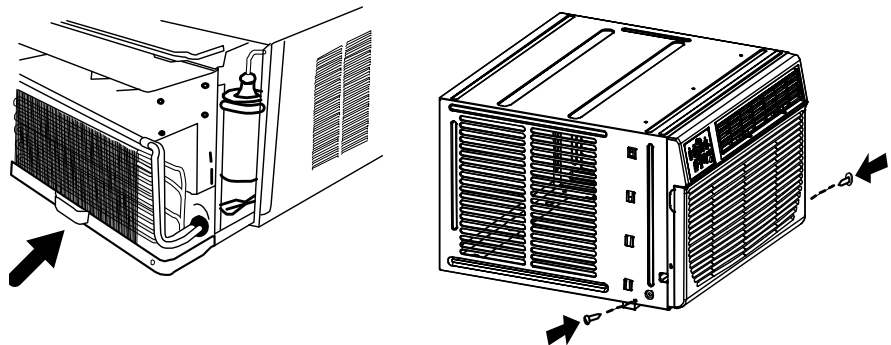









10. Press the on/off button to power on the unit.

Read control panel operations section for proper use.

NOTE: For Video Instructions on installing this product go to www.edgestar.com

Control Panel Operations

	On/Off
	Energy Saver
	Timer
	Mode
	Check Filter
	Fan Speed
	Sleep
	Temp/Timer Up
	Temp/Timer Down

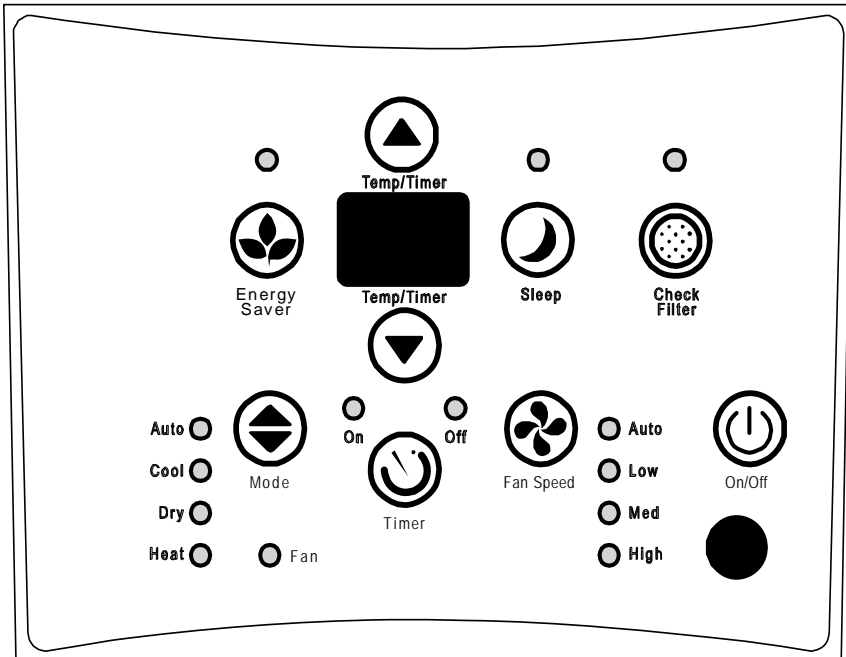



Using the Control Panel

To Turn Unit on:

Press  On/Off Button

To Change Temperature:

Press or hold either Up  or Down  button until desired temperature is seen on the digital display. This temperature will be automatically maintained anywhere between 62 °F (17°C) and 86°F (30°C). If you want the display to read the actual room temperature, see “To Operate on Fan only” section.

To Adjust Fan Speeds:

To select the speed of the fan press Fan Speed  in four steps- Auto, Low, Medium, or High. Each time the button is pressed the fan speed mode is shifted. NOTE- During "Dry mode" the fan speed is controlled at Low automatically.

To Select Operating Mode:

To choose operating mode press Mode . Each time you press the button a mode is selected in a sequence that goes from Auto, Cool, Dry, Heat to Fan. The indicator light beside will be illuminated and remain on once the mode is selected.

To operate on Auto Feature:

- When you set the unit to “Auto” mode it will automatically select cooling, heating, or fan only operation depending on the temperature selected and the current room temperature.
- Once the temperature you selected is achieved the unit will automatically maintain the room temperature.
- In this mode the fan speed cannot be adjusted. It will start automatically at a speed according to the actual room temperature.

To operate on Fan Only:

- Use this function only when cooling is not desired, such as for room circulation or to exhaust air (remember to open the vent). You can choose any speed you prefer.
- During this function the display will show the actual room temperature as in the cooling mode.
- In Fan only mode, the temperature is not adjusted.

To operate on Dry mode:

- In this mode, the air conditioner will operate as a dehumidifier. Because the conditioned space is closed or sealed some degree of cooling can be expected.





To Use Energy Saver Feature:

This function is available on “Cool” mode, press Energy Saver . The fan will continue to run for 3 minutes after the compressor shuts off. The fan then cycles on for 2 minutes at 10 minute intervals until the room temperature is above the set temperature at which the compressor turns back on and cooling starts.

To Use the Sleep Feature:

At the time of sleep press the sleep button . In this mode the selected temperature will increase (cooling) or decrease (heating) by 2°F (2°C) 30 minutes after the mode is selected. The temperature will then increase (cooling) or decrease (heating) by another 2°F (2°C) after an additional 30 minutes. This new temperature will be maintained for 6 hours before it returns to the originally selected temperature. This ends the Sleep mode and the unit will continue to operate as originally programmed. The Sleep Mode program can be cancelled at any time during operation by again pressing the Sleep button.

To Use Timer (Auto Start/Stop) Feature:

- When the unit is on or off, press the Timer button  the “Timer On” indicator light illuminates. It indicates the Auto Start program is initiated.
- To switch to off press the Timer button  again and the “Timer Off” indicator light illuminates. It indicates the Auto Stop program is initiated.
- Press or hold the Up  or Down  to change the Auto Time by ½ hour increments up to 10 hours or 1 hour increments up to 24 hours. The control will count down the time remaining until start.
- The selected time will register in 5 seconds and the system will automatically revert back to display the previous temperature setting or room temperature when the unit is on. (NOTE-when the unit is off there is no display)

To Check Filter Feature:

This feature is a reminder to clean the Air Filter for more efficient operation. The LED light will illuminate after 250 hours of operation. To reset after cleaning the filter press the Check Filter button and the light will go off.

Digital Display:

Displays the set temperature in “C” or “F” and the Auto-Timer settings. While on Fan only mode it shows the room temperature.

Error Codes

AS- Room temperature sensor error

- ✓ Unplug the unit and plug back in.
- ✓ If error repeats call for service.
- ✓ NOTE- In Fan only mode it will display “LO” or “HI”.

● - Evaporator temperature sensor error

- ✓ Unplug the unit and plug back in.
- ✓ If error repeats, call for service.

HS-Electric Heating sensor error

- ✓ Unplug the unit and plug back in.
- ✓ If error repeats, call for service.

Air Directional Louvers:

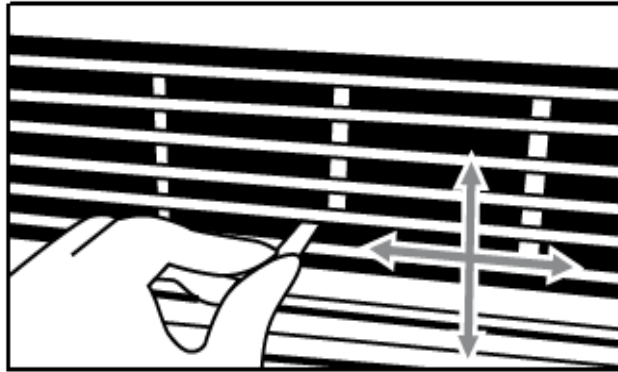

The 4-way air directional louvers allow you to direct the air flow Up, Down, Left, and Right throughout the room as needed. To adjust the air directional louvers side to side use the center handles as you move side to side.

Additional Tips:

The “Cool” mode has an automatic 3 minute timed delay start if the unit is turned off and on quickly. This prevents overheating of the compressor and possible circuit breaker tripping. The fan will continue to run during this time.

The control is capable of displaying the temperature in degrees Fahrenheit or degrees Celsius. To convert from one to the other, press and hold the Up and Down Temp/Timer buttons at the same time for 3 seconds.

Remote Operations

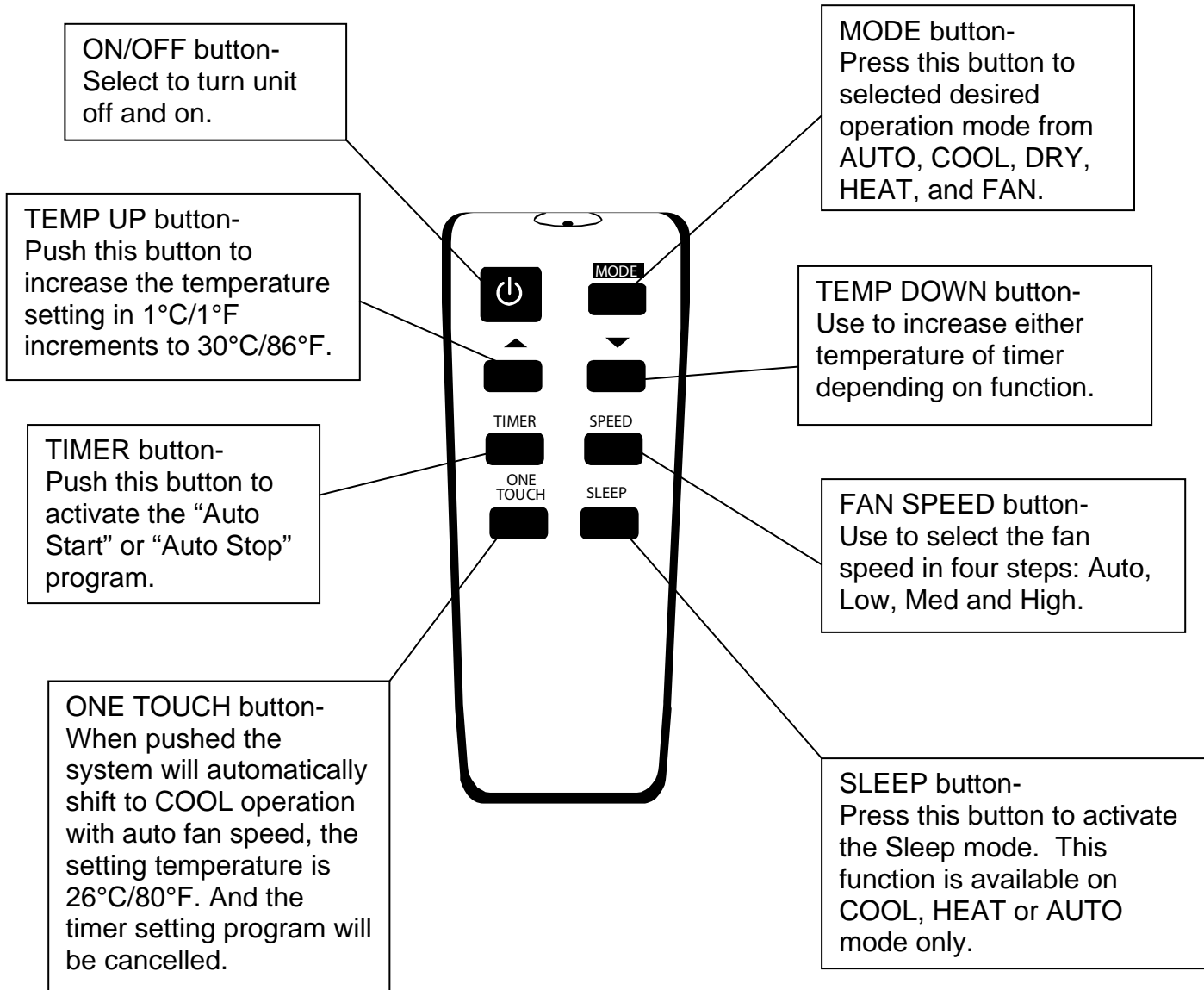

Maintenance

Clean the air conditioner and filters regularly to maximize performance and efficiency, and prolong the unit's life. Be sure to always unplug the air conditioner from the power outlet before cleaning.

Air Filter Cleaning

The air filter should be checked at least once a month to see if cleaning is necessary. Trapped particles in the filter can build up and could cause an accumulation of frost on the cooling coils.

NOTE: Winter Storage- If you plan to store the air conditioner during the winter, remove it carefully from the window according to the installation instructions. Make sure to clean the unit thoroughly and cover it with plastic or return it to the original carton.

1. Push the vent handle to the "vent closed" position.
2. Open the front panel.
3. Grasp the filter, pull up and out.
4. Wash the filter using liquid dishwashing detergent and warm water. Rinse filter thoroughly.
5. Gently shake excess water from the filter. Be sure the filter is thoroughly dry before replacing.
6. You also have the option of cleaning filter with vacuum.

Warning: Never use hot water over 40C (104F) to clean the air filter. Never attempt to operate the unit without the air filter.

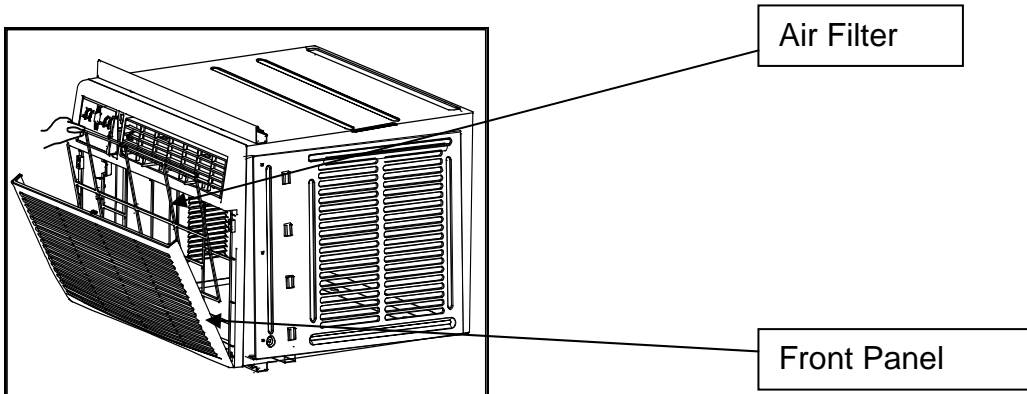

Cabinet Cleaning

- Be sure to unplug the air conditioner to prevent shock or fire hazard. The cabinet and front may be dusted with an oil-free cloth or washed with a cloth dampened in a solution of warm water and mild dishwashing detergent. Rinse thoroughly and wipe dry.
- Never use harsh cleaners, wax, or polish on the cabinet front.
- Be sure to wring excess water from the cloth before wiping around the controls. Excess water in or around the controls may cause damage to the air conditioner.

Normal Sounds

- High Pitched Chatter- High efficiency compressors may have a high pitched chatter during the cooling cycle.
- Sound of Rushing Air- At the front of the unit, you may hear the sound of rushing air being moved by the fan.
- Gurgle/Hiss- Gurgling or Hissing noise may be heard due to refrigerant passing through evaporator during normal operation.
- Vibration- Unit may vibrate and make noise because of poor wall or window construction or incorrect installation.
- Pinging or Switching- Droplets of water hitting condenser during normal operation may cause these sounds.

Energy Saving Guide

Read and follow the guide below to get the best performance and efficiency from your window air conditioner:

- Do not cover the air outlet (exhaust) while in use.
- Use the timer to operate the unit before it is needed. For example, set the timer to turn on the unit in cooling mode for 3 or more hours to cool the room before you arrive. You may want to operate the unit all day if you live in a warmer climate.
- Minimize the heat sources (direct sunlight, computers, servers, people, etc.) in the room.
- Close all windows and doors.
- Use the unit in a contained room. For example, a room with four walls and a ceiling, instead of a partitioned studio, or warehouse.
- Make sure the unit is secure with no gaps where air can escape.
- Minimize the amount of humidity in the room. For example, run the unit as a dehumidifier.
- To prolong the compressor's life, please wait at least 3 minutes before turning the unit back on after shutting it off.
- Inspect and keep the air filters clean by cleaning regularly.
- Perform routine maintenance.

Troubleshooting

Follow the troubleshooting guide below to resolve common issues.

Issue	Possible Cause	Solution
My air conditioner is not functioning at all	Wall plug disconnected	Make sure the unit is plugged in.
	LCDI power cord is tripped	Press the Reset button on the LCDI cord.
	House fuse blown or circuit breaker tripped.	Replace fuse with time delay type or reset circuit breaker.
	Control panel is off	Turn control panel ON and set to desired setting.
	Insufficient power	Move the unit to another outlet. Check your circuit breaker. (Refer to the rating label on the back of the unit to determine the Amperage draw).
Air from unit does not feel cold enough	Room temperature below 17°C (62°F)	Cooling may not occur until room temperature rises above 17°C (62°F).
	Temperature sensing element touching cold coil, located behind air filter	Straighten tube away from coil.
	Compressor shut-off by changing modes	Wait approximately 3 minutes and listen for compressor to restart when set in the COOL mode.
Air conditioner is cooling but room is too warm, ice is forming on cooling coil behind decorative front.	Outdoor temperature below 17°C (62°F)	To defrost the coil, set FAN ONLY mode.
	Air filter may be dirty	Clean Filter. Refer to maintenance section. To defrost set to FAN ONLY mode.
	Thermostat set too cold for night-time cooling.	To defrost the coil, set to FAN ONLY mode. Then, set temperature to higher setting.
Air conditioner is cooling but room is too warm, NO ice is forming on cooling coil behind decorative front.	Dirty air filter, air restricted	Clean air filter. Refer to maintenance section.
	Temperature is set too High	Set temperature to lower setting.
	Air directional louvers positioned improperly	Position louvers for better air distribution.
	Front of unit is blocked by drapes, blinds, furniture, etc., restricts air distribution	Clear blockage in front of unit.

Issue	Possible Cause	Solution
Air conditioner is cooling but room is too warm, NO ice is forming on cooling coil behind decorative front	Open doors, windows, etc.	Open = cold air escapes. Close doors, windows, etc.
	Unit recently turned on in hot room	Allow additional time to remove "stored heat" from walls, ceiling, floor and furniture.
Air conditioner turns on and off rapidly	Dirty air filter, air restricted	Clean air filter.
	Outside temperature extremely hot	Set FAN speed to a higher setting to bring air past cooling coils more frequently.
Noise when unit is cooling	Air movement sound, this is normal	If too loud, set to a slower FAN setting.
	Window vibration due to poor installation	Refer to installation instructions.
Water dripping INSIDE when unit is cooling	Improper installation	Tilt air conditioner slightly to the outside to allow water drainage.
	Unit removing large quantity of moisture from humid room	This is normal during excessively humid days.
Remote not sensing	Remote control not located within range	Place remote control with 20 feet and 180 degrees radius of the front of the unit.
	Remote control signal obstructed	Remove obstruction.
Room too cold	Set temperature too low	Increase set temperature.

Specifications

Description of product	Window Air Conditioner
Model	WAC8000W
Voltage/Frequency	115 V / 60 HZ
Input Power	1010W
Current	Starting Current- 34.4A Max Current- 9.5A
Color	White
Coolant	R410A
Timer	24 Hour
Dimensions H x W x D	15.6" x 23" x 23.4"
Weight	71.7 Lbs.

EdgeStar Limited Warranty

One (1) Year Parts & Ninety (90) Days Labor

This product is warranted by EdgeStar to be free from defective workmanship and materials, subject to any conditions set forth as follows:

WHAT IS COVERED:

LABOR: For a period of NINETY (90) DAYS from the date of original purchase, labor will be performed free of charge at an authorized EdgeStar repair facility. At its option, EdgeStar will repair the product with new or remanufactured parts, or exchange the defective product with a new, refurbished, or remanufactured product. If a product is replaced, it will carry the remaining warranty of the original product. After the ninety (90) day period, EdgeStar will no longer be responsible for labor charges incurred. All defective products and parts covered by this warranty will be repaired or replaced on a mail-in basis to an EdgeStar authorized repair facility.

PARTS: For a period of ONE (1) YEAR from the date of original purchase, EdgeStar will supply new, rebuilt, or refurbished parts free of charge. EdgeStar may request a defective part be returned in exchange for the replacement part. All replacement parts or products will be new, remanufactured, or refurbished. All products and parts replaced by EdgeStar under warranty service become the property of EdgeStar.

This warranty applies to the original purchaser only, and only covers defects in workmanship experienced during operation of the product under normal service, maintenance, and usage conditions. This warranty applies to the purchase and use of this product in residential settings within the United States of America.

WHAT IS NOT COVERED:

The following limitations apply to the coverage of this warranty. This warranty does not cover:

- Labor charges for installation, setup or training to use the product.
- Shipping damage, and any damage caused by improper packaging for shipment to an authorized service center, and any damaged caused by improper voltage or any other misuse, including abnormal service, handling, or usage.
- Cosmetic damage such as scratches and dents.
- Normal wear and tear on parts or replacement of parts designed to be replaced, e.g. filters, cartridges, batteries.
- Service trips to deliver, pick-up, or repair, install the product, or to instruct in proper usage of the product.
- Damages or operating problems resulting from misuse, abuse, operation outside environmental specifications, uses contrary to instructions provided in the owner's manual, accidents, acts of God, vermin, fire, flood, improper installation, unauthorized service, maintenance negligence, unauthorized installation or modification, or commercial use.
- Labor charges incurred 91 days or more after the date of original purchase.
- The use of EdgeStar products in commercial settings.
- Optional accessories, attachments, and appearance items.
- Products that have been modified to perform outside of specifications without the prior written permission of EdgeStar.
- Products lost in shipment, or theft.
- Products sold AS IS or from an unauthorized reseller.
- Products that have had their serial numbers removed or defaced. Products with serial numbers that have been invalidated.

OBTAINING WARRANTY SERVICE:

If you believe your product is defective, contact EdgeStar Customer Support for troubleshooting assistance and warranty service at 1-866-319-5473. Please have your serial number and proof of purchase available. Once an EdgeStar authorized representative has confirmed that your product is defective and eligible for warranty service, the product must be returned to an EdgeStar repair facility. The purchaser is solely responsible for prepaying all shipping related costs to and from the repair facility. EdgeStar is not responsible for damage resulting from shipper mishandling or improper packaging. Do not return a defective product to the place of purchase. Products received without a return authorization number will be refused.

THIS WARRANTY IS IN LIEU OF ANY OTHER WARRANTY, EXPRESSED OR IMPLIED, INCLUDING WITHOUT LIMITATION, ANY WARRANTY OF MERCHANTABILITY OR FITNESS FOR A PARTICULAR PURPOSE. TO THE EXTENT ANY IMPLIED WARRANTY IS REQUIRED BY LAW, IT IS LIMITED IN DURATION TO THE EXPRESS WARRANTY PERIOD ABOVE. NEITHER THE MANUFACTURER NOR ITS DISTRIBUTORS SHALL BE LIABLE FOR ANY INCIDENTAL, CONSEQUENTIAL, INDIRECT, SPECIAL, OR PUNITIVE DAMAGES OF ANY NATURE, INCLUDING WITHOUT LIMITATION, LOST REVENUES OR PROFITS, OR ANY OTHER DAMAGE WHETHER BASED IN CONTRACT, TORT, OR OTHERWISE. SOME STATES DO NOT ALLOW THE EXCLUSION OF INCIDENTAL OR CONSEQUENTIAL DAMAGES, SO THE ABOVE EXCLUSION MAY NOT APPLY TO YOU. THIS WARRANTY GIVES YOU SPECIFIC LEGAL RIGHTS. YOU MAY HAVE OTHER RIGHTS THAT VARY FROM STATE TO STATE.

Koldfront

By

EdgeStar Products
Box 81336
Austin, TX 78708-1336

Web: <http://www.edgestar.com>
E-mail: service@edgestar.com

Register your product, download owner's manuals, access additional troubleshooting resources, and obtain more information on other great EdgeStar & KoldFront products on the web at: [**http://www.edgestar.com**](http://www.edgestar.com)

Product contents and specifications may change without notice.

Copyright © 2011 Living Direct, Inc.